

PHILIPPINE BIDDING DOCUMENTS

***Re-bid: Installation
of Solar Street
Lights - Lagab***

PID NO. 2023 – 032-A

Government of the Republic of the Philippines

**Sixth Edition
July 2020**

TABLE OF CONTENTS

Glossary of Terms, Abbreviations, and Acronyms	4
Section I. Invitation to Bid.....	7
Section II. Instructions to Bidders	10
1. Scope of Bid.....	11
2. Funding Information	11
3. Bidding Requirements.....	11
4. Corrupt, Fraudulent, Collusive, Coercive, and Obstructive Practices	11
5. Eligible Bidders.....	12
6. Origin of Associated Goods	12
7. Subcontracts	12
8. Pre-Bid Conference.....	12
9. Clarification and Amendment of Bidding Documents.....	13
10. Documents Comprising the Bid: Eligibility and Technical Components ...	13
11. Documents Comprising the Bid: Financial Component	13
12. Alternative Bids	14
13. Bid Prices	14
14. Bid and Payment Currencies.....	14
15. Bid Security.....	14
16. Sealing and Marking of Bids.....	14
17. Deadline for Submission of Bids	15
18. Opening and Preliminary Examination of Bids	15
19. Detailed Evaluation and Comparison of Bids.....	15
20. Post Qualification.....	15
21. Signing of the Contract	16
Section III. Bid Data Sheet	17
Section IV. General Conditions of Contract.....	19
1. Scope of Contract.....	20
2. Sectional Completion of Works	20
3. Possession of Site	20
4. The Contractor's Obligations.....	20
5. Performance Security	21
6. Site Investigation Reports	21

7.	Warranty.....	21
8.	Liability of the Contractor.....	21
9.	Termination for Other Causes.....	21
10.	Dayworks	21
11.	Program of Work.....	22
12.	Instructions, Inspections and Audits	22
13.	Advance Payment.....	22
14.	Progress Payments	22
15.	Operating and Maintenance Manuals.....	22
	Section V. Special Conditions of Contract.....	24
	Section VI. Specifications	26
	Section VII. Drawings.....	37
	Section VIII. Bill of Quantities	39
	Section IX. Checklist of Technical and Financial Documents	40

Glossary of Terms, Abbreviations, and Acronyms

ABC – Approved Budget for the Contract.

ARCC – Allowable Range of Contract Cost.

BAC – Bids and Awards Committee.

Bid – A signed offer or proposal to undertake a contract submitted by a bidder in response to and in consonance with the requirements of the bidding documents. Also referred to as *Proposal* and *Tender*. (2016 revised IRR, Section 5[c])

Bidder – Refers to a contractor, manufacturer, supplier, distributor and/or consultant who submits a bid in response to the requirements of the Bidding Documents. (2016 revised IRR, Section 5[d])

Bidding Documents – The documents issued by the Procuring Entity as the bases for bids, furnishing all information necessary for a prospective bidder to prepare a bid for the Goods, Infrastructure Projects, and/or Consulting Services required by the Procuring Entity. (2016 revised IRR, Section 5[e])

BIR – Bureau of Internal Revenue.

BSP – Bangko Sentral ng Pilipinas.

CDA – Cooperative Development Authority.

Consulting Services – Refer to services for Infrastructure Projects and other types of projects or activities of the GOP requiring adequate external technical and professional expertise that are beyond the capability and/or capacity of the GOP to undertake such as, but not limited to: (i) advisory and review services; (ii) pre-investment or feasibility studies; (iii) design; (iv) construction supervision; (v) management and related services; and (vi) other technical services or special studies. (2016 revised IRR, Section 5[i])

Contract – Refers to the agreement entered into between the Procuring Entity and the Supplier or Manufacturer or Distributor or Service Provider for procurement of Goods and Services; Contractor for Procurement of Infrastructure Projects; or Consultant or Consulting Firm for Procurement of Consulting Services; as the case may be, as recorded in the Contract Form signed by the parties, including all attachments and appendices thereto and all documents incorporated by reference therein.

Contractor – is a natural or juridical entity whose proposal was accepted by the Procuring Entity and to whom the Contract to execute the Work was awarded. Contractor as used in these Bidding Documents may likewise refer to a supplier, distributor, manufacturer, or consultant.

CPI – Consumer Price Index.

DOLE – Department of Labor and Employment.

DTI – Department of Trade and Industry.

Foreign-funded Procurement or Foreign-Assisted Project – Refers to procurement whose funding source is from a foreign government, foreign or international financing institution as specified in the Treaty or International or Executive Agreement. (2016 revised IRR, Section 5[b]).

GFI – Government Financial Institution.

GOCC – Government-owned and/or –controlled corporation.

Goods – Refer to all items, supplies, materials and general support services, except Consulting Services and Infrastructure Projects, which may be needed in the transaction of public businesses or in the pursuit of any government undertaking, project or activity, whether in the nature of equipment, furniture, stationery, materials for construction, or personal property of any kind, including non-personal or contractual services such as the repair and maintenance of equipment and furniture, as well as trucking, hauling, janitorial, security, and related or analogous services, as well as procurement of materials and supplies provided by the Procuring Entity for such services. The term “related” or “analogous services” shall include, but is not limited to, lease or purchase of office space, media advertisements, health maintenance services, and other services essential to the operation of the Procuring Entity. (2016 revised IRR, Section 5[r])

GOP – Government of the Philippines.

Infrastructure Projects – Include the construction, improvement, rehabilitation, demolition, repair, restoration or maintenance of roads and bridges, railways, airports, seaports, communication facilities, civil works components of information technology projects, irrigation, flood control and drainage, water supply, sanitation, sewerage and solid waste management systems, shore protection, energy/power and electrification facilities, national buildings, school buildings, hospital buildings, and other related construction projects of the government. Also referred to as *civil works or works*. (2016 revised IRR, Section 5[u])

LGUs – Local Government Units.

NFCC – Net Financial Contracting Capacity.

NGA – National Government Agency.

PCAB – Philippine Contractors Accreditation Board.

PhilGEPS - Philippine Government Electronic Procurement System.

Procurement Project – refers to a specific or identified procurement covering goods, infrastructure project or consulting services. A Procurement Project shall be described, detailed, and scheduled in the Project Procurement Management Plan prepared by the agency which shall be consolidated in the procuring entity's Annual Procurement Plan. (GPPB Circular No. 06-2019 dated 17 July 2019)

PSA – Philippine Statistics Authority.

SEC – Securities and Exchange Commission.

SLCC – Single Largest Completed Contract.

UN – United Nations.

Section I. Invitation to Bid



Republic of the Philippines
Province of Davao de Oro
MUNICIPALITY OF COMPOSTELA
BIDS AND AWARDS COMMITTEE
CP#: 0909-279-9827



Invitation to Bid for ***Re-bid: Installation of Solar Street Lights - Lagab***

1. The *Municipality of Compostela*, through the *General Fund* intends to apply the sum of *Nine Hundred Ninety-Nine Thousand Nine Hundred Ninety-Nine Pesos and Eighty-Four Centavos (P999,999.84)* being the Approved Budget for the Contract (ABC) to payments under the contract for *Re-bid: Installation of Solar Street Lights - Lagab with Project Identification No. 2023-032-A*. Bids received in excess of the ABC shall be automatically rejected at bid opening.
2. The Municipality of Compostela now invites bids for the above Procurement Project. Completion of the Works is required *90 calendar days*. Bidders should have completed a contract similar to the Project. The description of an eligible bidder is contained in the Bidding Documents, particularly, in Section II (Instructions to Bidders).
3. Bidding will be conducted through open competitive bidding procedures using non-discretionary "*pass/fail*" criterion as specified in the 2016 revised Implementing Rules and Regulations (IRR) of Republic Act (RA) No. 9184.
4. Interested bidders may obtain further information from Municipality of Compostela and inspect the Bidding Documents at the address given below from *8:00 a.m. to 5:00 p.m.*
5. A complete set of Bidding Documents may be acquired by interested bidders on ***March 27, 2023 to April 18, 2023*** from given address and website below *upon payment of the applicable fee for the Bidding Documents, pursuant to the latest Guidelines issued by the GPPB, in the amount of One Thousand Pesos (P1,000.00)*. The Procuring Entity shall allow the bidder to present its proof of payment for the fees ***presented in person***.
6. The Municipality of Compostela will hold a Pre-Bid Conference on ***April 4, 2023 at 1:30 p.m.*** at Office of the BAC, 2nd Floor, Municipal Hall Building, Dagohoy St., Purok 2, Poblacion, Compostela, Davao de Oro which shall be open to prospective bidders.
7. Bids must be duly received by the BAC Secretariat through manual submission at the office address as indicated below on ***April 18, 2023 at 1:00 p.m.*** Late bids shall not be accepted.
8. All bids must be accompanied by a bid security in any of the acceptable forms and in the amount stated in **ITB** Clause 16.

9. Bid opening shall be on ***April 18, 2023 at 1:30 p.m.*** at the given address below. Bids will be opened in the presence of the bidders' representatives who choose to attend the activity.
10. The *Municipality of Compostela* reserves the right to reject any and all bids, declare a failure of bidding, or not award the contract at any time prior to contract award in accordance with Sections 35.6 and 41 of the 2016 revised Implementing Rules and Regulations (IRR) of RA No. 9184, without thereby incurring any liability to the affected bidder or bidders.
11. For further information, please refer to:

EDWARD FORD N. DAGATAN
BAC Office
2nd Floor, Municipal Hall Building, Dagohoy St., Purok 2,
Poblacion, Compostela, Davao de Oro
CP#: 0909-279-9827
Email Add: compobacsec@gmail.com
12. You may visit **www.philgeps.gov.ph** and search for Municipality of Compostela for downloading of Bidding Documents.

March 27, 2023

(Sgd.)
LUCELIA L. PAQUEO
BAC Chairperson

Section II. Instructions to Bidders

1. Scope of Bid

The Procuring Entity, *Municipality of Compostela*, invites Bids for the *Re-bid: Installation of Solar Street Lights - Lagab* with Project Identification Number 2023 – 032-A.

[Note: The Project Identification Number is assigned by the Procuring Entity based on its own coding scheme and is not the same as the PhilGEPS reference number, which is generated after the posting of the bid opportunity on the PhilGEPS website.]

The Procurement Project (referred to herein as “Project”) is for the construction of Works, as described in Section VI (Specifications).

2. Funding Information

2.1. The GOP through the source of funding as indicated below for CY 2023 in the amount of *Nine Hundred Ninety-Nine Thousand Nine Hundred Ninety-Nine Pesos and Eighty-Four Centavos (P999,999.84)*.

2.2. The source of funding is: LGUs, the Annual Budget, as approved by the Sanggunian.

3. Bidding Requirements

The Bidding for the Project shall be governed by all the provisions of RA No. 9184 and its 2016 revised IRR, including its Generic Procurement Manual and associated policies, rules and regulations as the primary source thereof, while the herein clauses shall serve as the secondary source thereof.

Any amendments made to the IRR and other GPPB issuances shall be applicable only to the ongoing posting, advertisement, or invitation to bid by the BAC through the issuance of a supplemental or bid bulletin.

The Bidder, by the act of submitting its Bid, shall be deemed to have inspected the site, determined the general characteristics of the contracted Works and the conditions for this Project, such as the location and the nature of the work; (b) climatic conditions; (c) transportation facilities; (c) nature and condition of the terrain, geological conditions at the site communication facilities, requirements, location and availability of construction aggregates and other materials, labor, water, electric power and access roads; and (d) other factors that may affect the cost, duration and execution or implementation of the contract, project, or work and examine all instructions, forms, terms, and project requirements in the Bidding Documents.

4. Corrupt, Fraudulent, Collusive, Coercive, and Obstructive Practices

The Procuring Entity, as well as the Bidders and Contractors, shall observe the highest standard of ethics during the procurement and execution of the contract. They or

through an agent shall not engage in corrupt, fraudulent, collusive, coercive, and obstructive practices defined under Annex “I” of the 2016 revised IRR of RA No. 9184 or other integrity violations in competing for the Project.

5. Eligible Bidders

- 5.1. Only Bids of Bidders found to be legally, technically, and financially capable will be evaluated.
- 5.2. The Bidder must have an experience of having completed a Single Largest Completed Contract (SLCC) that is similar to this Project, equivalent to at least fifty percent (50%) of the ABC adjusted, if necessary, by the Bidder to current prices using the PSA’s CPI, except under conditions provided for in Section 23.4.2.4 of the 2016 revised IRR of RA No. 9184.

A contract is considered to be “similar” to the contract to be bid if it has the major categories of work stated in the **BDS**.

- 5.3. For Foreign-funded Procurement, the Procuring Entity and the foreign government/foreign or international financing institution may agree on another track record requirement, as specified in the Bidding Document prepared for this purpose.
- 5.4. The Bidders shall comply with the eligibility criteria under Section 23.4.2 of the 2016 IRR of RA No. 9184.

6. Origin of Associated Goods

There is no restriction on the origin of Goods other than those prohibited by a decision of the UN Security Council taken under Chapter VII of the Charter of the UN.

7. Subcontracts

- 7.1. The Bidder may subcontract portions of the Project to the extent allowed by the Procuring Entity as stated herein, but in no case more than fifty percent (50%) of the Project.

The Procuring Entity has prescribed that: ***Subcontracting is not allowed.***

- 7.2. Subcontracting of any portion of the Project does not relieve the Contractor of any liability or obligation under the Contract. The Supplier will be responsible for the acts, defaults, and negligence of any subcontractor, its agents, servants, or workmen as fully as if these were the Contractor’s own acts, defaults, or negligence, or those of its agents, servants, or workmen.

8. Pre-Bid Conference

The Procuring Entity will hold a pre-bid conference for this Project on the specified date and time and either at its physical address at the *Office of the BAC, 2nd Floor*,

Municipal Hall Building, Dagohoy St., Purok 2, Poblacion, Compostela, Davao de Oro as indicated in paragraph 6 of the **IB**.

9. Clarification and Amendment of Bidding Documents

Prospective bidders may request for clarification on and/or interpretation of any part of the Bidding Documents. Such requests must be in writing and received by the Procuring Entity, either at its given address or through electronic mail indicated in the **IB**, at least ten (10) calendar days before the deadline set for the submission and receipt of Bids.

10. Documents Comprising the Bid: Eligibility and Technical Components

- 10.1. The first envelope shall contain the eligibility and technical documents of the Bid as specified in **Section IX. Checklist of Technical and Financial Documents**.
- 10.2. If the eligibility requirements or statements, the bids, and all other documents for submission to the BAC are in foreign language other than English, it must be accompanied by a translation in English, which shall be authenticated by the appropriate Philippine foreign service establishment, post, or the equivalent office having jurisdiction over the foreign bidder's affairs in the Philippines. For Contracting Parties to the Apostille Convention, only the translated documents shall be authenticated through an apostille pursuant to GPPB Resolution No. 13-2019 dated 23 May 2019. The English translation shall govern, for purposes of interpretation of the bid.
- 10.3. A valid PCAB License is required, and in case of joint ventures, a valid special PCAB License, and registration for the type and cost of the contract for this Project. Any additional type of Contractor license or permit shall be indicated in the **BDS**.
- 10.4. A List of Contractor's key personnel (e.g., Project Manager, Project Engineers, Materials Engineers, and Foremen) assigned to the contract to be bid, with their complete qualification and experience data shall be provided. These key personnel must meet the required minimum years of experience set in the **BDS**.
- 10.5. A List of Contractor's major equipment units, which are owned, leased, and/or under purchase agreements, supported by proof of ownership, certification of availability of equipment from the equipment lessor/vendor for the duration of the project, as the case may be, must meet the minimum requirements for the contract set in the **BDS**.

11. Documents Comprising the Bid: Financial Component

- 11.1. The second bid envelope shall contain the financial documents for the Bid as specified in **Section IX. Checklist of Technical and Financial Documents**.

- 11.2. Any bid exceeding the ABC indicated in paragraph 1 of the **IB** shall not be accepted.
- 11.3. For Foreign-funded procurement, a ceiling may be applied to bid prices provided the conditions are met under Section 31.2 of the 2016 revised IRR of RA No. 9184.

12. Alternative Bids

Bidders shall submit offers that comply with the requirements of the Bidding Documents, including the basic technical design as indicated in the drawings and specifications. Unless there is a value engineering clause in the **BDS**, alternative Bids shall not be accepted.

13. Bid Prices

All bid prices for the given scope of work in the Project as awarded shall be considered as fixed prices, and therefore not subject to price escalation during contract implementation, except under extraordinary circumstances as determined by the NEDA and approved by the GPPB pursuant to the revised Guidelines for Contract Price Escalation guidelines.

14. Bid and Payment Currencies

- 14.1. Bid prices may be quoted in the local currency or tradeable currency accepted by the BSP at the discretion of the Bidder. However, for purposes of bid evaluation, Bids denominated in foreign currencies shall be converted to Philippine currency based on the exchange rate as published in the BSP reference rate bulletin on the day of the bid opening.
- 14.2. Payment of the contract price shall be made in: *Philippine Pesos*.

15. Bid Security

- 15.1. The Bidder shall submit a Bid Securing Declaration or any form of Bid Security in the amount indicated in the **BDS**, which shall be not less than the percentage of the ABC in accordance with the schedule in the **BDS**.
- 15.2. The Bid and bid security shall be valid until *One Hundred Twenty (120) days*. Any bid not accompanied by an acceptable bid security shall be rejected by the Procuring Entity as non-responsive.

16. Sealing and Marking of Bids

Each Bidder shall submit one copy of the first and second components of its Bid.

The Procuring Entity may request additional hard copies and/or electronic copies of the Bid. However, failure of the Bidders to comply with the said request shall not be a ground for disqualification.

If the Procuring Entity allows the submission of bids through online submission to the given website or any other electronic means, the Bidder shall submit an electronic copy of its Bid, which must be digitally signed. An electronic copy that cannot be opened or is corrupted shall be considered non-responsive and, thus, automatically disqualified.

17. Deadline for Submission of Bids

The Bidders shall submit on the specified date and time and either at its physical address or through online submission as indicated in paragraph 7 of the **IB**.

18. Opening and Preliminary Examination of Bids

18.1. The BAC shall open the Bids in public at the time, on the date, and at the place specified in paragraph 9 of the **IB**. The Bidders' representatives who are present shall sign a register evidencing their attendance. In case videoconferencing, webcasting or other similar technologies will be used, attendance of participants shall likewise be recorded by the BAC Secretariat.

In case the Bids cannot be opened as scheduled due to justifiable reasons, the rescheduling requirements under Section 29 of the 2016 revised IRR of RA No. 9184 shall prevail.

18.2. The preliminary examination of Bids shall be governed by Section 30 of the 2016 revised IRR of RA No. 9184.

19. Detailed Evaluation and Comparison of Bids

19.1. The Procuring Entity's BAC shall immediately conduct a detailed evaluation of all Bids rated "*passed*" using non-discretionary pass/fail criteria. The BAC shall consider the conditions in the evaluation of Bids under Section 32.2 of 2016 revised IRR of RA No. 9184.

19.2. If the Project allows partial bids, all Bids and combinations of Bids as indicated in the **BDS** shall be received by the same deadline and opened and evaluated simultaneously so as to determine the Bid or combination of Bids offering the lowest calculated cost to the Procuring Entity. Bid Security as required by **ITB** Clause 15 shall be submitted for each contract (lot) separately.

19.3. In all cases, the NFCC computation pursuant to Section 23.4.2.6 of the 2016 revised IRR of RA No. 9184 must be sufficient for the total of the ABCs for all the lots participated in by the prospective Bidder.

20. Post Qualification

Within a non-extendible period of five (5) calendar days from receipt by the Bidder of the notice from the BAC that it submitted the Lowest Calculated Bid, the Bidder shall submit its latest income and business tax returns filed and paid through the BIR

Electronic Filing and Payment System (eFPS), and other appropriate licenses and permits required by law and stated in the **BDS**.

21. Signing of the Contract

The documents required in Section 37.2 of the 2016 revised IRR of RA No. 9184 shall form part of the Contract. Additional Contract documents are indicated in the **BDS**.

Section III. Bid Data Sheet

Bid Data Sheet

ITB Clause			
5.2	For this purpose, contracts similar to the Project refer to contracts which have the same major categories of work, which shall be: <i>ELECTRICAL WORKS</i>		
7.1	<i>Subcontracting is not allowed.</i>		
10.3	<i>No further instruction.</i>		
10.4	The key personnel must meet the required minimum years of experience set below:		
	<u>Key Personnel</u>	<u>General Experience</u>	<u>Relevant Experience</u>
	Civil Engineer	5 years	3 years
	Foreman	3 years	1 year
	Electrician	3 years	1 year
	Mason	3 years	1 year
	Operators	3 years	1 year
10.5	The minimum major equipment requirements are the following:		
	<u>Equipment</u>	<u>Capacity</u>	<u>Number of Units</u>
12	<i>[Insert Value Engineering clause if allowed.]</i>		
15.1	The bid security shall be in the form of a Bid Securing Declaration or any of the following forms and amounts: a. The amount of not less than P 20,000.00 <i>[Two percent (2%) of ABC]</i> , if bid security is in cash, cashier's/manager's check, bank draft/guarantee or irrevocable letter of credit; b. The amount of not less than P 49,999.99 <i>[Five percent (5%) of ABC]</i> if bid security is in Surety Bond.		
19.2	Partial bid is not allowed. The infrastructure project is packaged in a single lot and the lot shall not be divided into sub-lots for the purpose of bidding, evaluation, and contract award.		
20	No further instructions.		
21	Additional contract documents are the following: NONE		

Section IV. General Conditions of Contract

1. Scope of Contract

This Contract shall include all such items, although not specifically mentioned, that can be reasonably inferred as being required for its completion as if such items were expressly mentioned herein. All the provisions of RA No. 9184 and its 2016 revised IRR, including the Generic Procurement Manual, and associated issuances, constitute the primary source for the terms and conditions of the Contract, and thus, applicable in contract implementation. Herein clauses shall serve as the secondary source for the terms and conditions of the Contract.

This is without prejudice to Sections 74.1 and 74.2 of the 2016 revised IRR of RA No. 9184 allowing the GPPB to amend the IRR, which shall be applied to all procurement activities, the advertisement, posting, or invitation of which were issued after the effectivity of the said amendment.

2. Sectional Completion of Works

If sectional completion is specified in the **Special Conditions of Contract (SCC)**, references in the Conditions of Contract to the Works, the Completion Date, and the Intended Completion Date shall apply to any Section of the Works (other than references to the Completion Date and Intended Completion Date for the whole of the Works).

3. Possession of Site

3.1 The Procuring Entity shall give possession of all or parts of the Site to the Contractor based on the schedule of delivery indicated in the **SCC**, which corresponds to the execution of the Works. If the Contractor suffers delay or incurs cost from failure on the part of the Procuring Entity to give possession in accordance with the terms of this clause, the Procuring Entity's Representative shall give the Contractor a Contract Time Extension and certify such sum as fair to cover the cost incurred, which sum shall be paid by Procuring Entity.

3.2 If possession of a portion is not given by the above date, the Procuring Entity will be deemed to have delayed the start of the relevant activities. The resulting adjustments in contract time to address such delay may be addressed through contract extension provided under Annex "E" of the 2016 revised IRR of RA No. 9184.

4. The Contractor's Obligations

The Contractor shall employ the key personnel named in the Schedule of Key Personnel indicating their designation, in accordance with **ITB** Clause 10.3 and specified in the **BDS**, to carry out the supervision of the Works.

The Procuring Entity will approve any proposed replacement of key personnel only if their relevant qualifications and abilities are equal to or better than those of the personnel listed in the Schedule.

5. Performance Security

- 5.1. Within ten (10) calendar days from receipt of the Notice of Award from the Procuring Entity but in no case later than the signing of the contract by both parties, the successful Bidder shall furnish the performance security in any of the forms prescribed in Section 39 of the 2016 revised IRR.
- 5.2. The Contractor, by entering into the Contract with the Procuring Entity, acknowledges the right of the Procuring Entity to institute action pursuant to RA No. 3688 against any subcontractor be they an individual, firm, partnership, corporation, or association supplying the Contractor with labor, materials and/or equipment for the performance of this Contract.

6. Site Investigation Reports

The Contractor, in preparing the Bid, shall rely on any Site Investigation Reports referred to in the SCC supplemented by any information obtained by the Contractor.

7. Warranty

- 7.1. In case the Contractor fails to undertake the repair works under Section 62.2.2 of the 2016 revised IRR, the Procuring Entity shall forfeit its performance security, subject its property(ies) to attachment or garnishment proceedings, and perpetually disqualify it from participating in any public bidding. All payables of the GOP in his favor shall be offset to recover the costs.
- 7.2. The warranty against Structural Defects/Failures, except that occasioned-on force majeure, shall cover the period from the date of issuance of the Certificate of Final Acceptance by the Procuring Entity. Specific duration of the warranty is found in the SCC.

8. Liability of the Contractor

Subject to additional provisions, if any, set forth in the SCC, the Contractor's liability under this Contract shall be as provided by the laws of the Republic of the Philippines.

If the Contractor is a joint venture, all partners to the joint venture shall be jointly and severally liable to the Procuring Entity.

9. Termination for Other Causes

Contract termination shall be initiated in case it is determined *prima facie* by the Procuring Entity that the Contractor has engaged, before, or during the implementation of the contract, in unlawful deeds and behaviors relative to contract acquisition and implementation, such as, but not limited to corrupt, fraudulent, collusive, coercive, and obstructive practices as stated in ITB Clause 4.

10. Dayworks

Subject to the guidelines on Variation Order in Annex “E” of the 2016 revised IRR of RA No. 9184, and if applicable as indicated in the **SCC**, the Dayworks rates in the Contractor’s Bid shall be used for small additional amounts of work only when the Procuring Entity’s Representative has given written instructions in advance for additional work to be paid for in that way.

11. Program of Work

11.1. The Contractor shall submit to the Procuring Entity’s Representative for approval the said Program of Work showing the general methods, arrangements, order, and timing for all the activities in the Works. The submissions of the Program of Work are indicated in the **SCC**.

11.2. The Contractor shall submit to the Procuring Entity’s Representative for approval an updated Program of Work at intervals no longer than the period stated in the **SCC**. If the Contractor does not submit an updated Program of Work within this period, the Procuring Entity’s Representative may withhold the amount stated in the **SCC** from the next payment certificate and continue to withhold this amount until the next payment after the date on which the overdue Program of Work has been submitted.

12. Instructions, Inspections and Audits

The Contractor shall permit the GOP or the Procuring Entity to inspect the Contractor’s accounts and records relating to the performance of the Contractor and to have them audited by auditors of the GOP or the Procuring Entity, as may be required.

13. Advance Payment

The Procuring Entity shall, upon a written request of the Contractor which shall be submitted as a Contract document, make an advance payment to the Contractor in an amount not exceeding fifteen percent (15%) of the total contract price, to be made in lump sum, or at the most two installments according to a schedule specified in the **SCC**, subject to the requirements in Annex “E” of the 2016 revised IRR of RA No. 9184.

14. Progress Payments

The Contractor may submit a request for payment for Work accomplished. Such requests for payment shall be verified and certified by the Procuring Entity’s Representative/Project Engineer. Except as otherwise stipulated in the **SCC**, materials and equipment delivered on the site but not completely put in place shall not be included for payment.

15. Operating and Maintenance Manuals

15.1. If required, the Contractor will provide “as built” Drawings and/or operating and maintenance manuals as specified in the **SCC**.

- 15.2. If the Contractor does not provide the Drawings and/or manuals by the dates stated above, or they do not receive the Procuring Entity's Representative's approval, the Procuring Entity's Representative may withhold the amount stated in the **SCC** from payments due to the Contractor.

Section V. Special Conditions of Contract

Special Conditions of Contract

GCC Clause	
2	<i>Not applicable.</i>
4.1	<i>The procuring entity shall give possession of all parts of the site to the contractor upon receipt of the NTP.</i>
6	The site investigation reports are: <i>none</i>
7.2	Five (5) years.
10	No dayworks are applicable to the contract.
11.1	The Contractor shall submit the Program of Work to the Procuring Entity's Representative within <i>Ten (10)</i> days of delivery of the Notice of Award.
11.2	The amount to be withheld for late submission of an updated Program of Work is Fifty Thousand Pesos (P50,000.00).
13	The amount of the advance payment shall not exceed 15% of the total contract price which will only be released upon complete mobilization.
14	Materials and equipment delivered on the site but not completely put in place shall be included for payment.
15.1	The date by which operating and maintenance manuals are required is upon acceptance of the project. The date by which "as built" drawings are required is prior to the release of certificate of completion.
15.2	The amount to be withheld for failing to produce "as built" drawings and/or operating and maintenance manuals by the date required is <i>one percent (1%) of the contract amount.</i>

Section VI. Specifications

PROJECT NAME: INSTALLATION OF SOLAR STREET LIGHTS - LAGAB
PROJECT LOCATION: BRGY. LAGAB COMPOSTELA, DAVAO DE ORO
PROJECT DESCRIPTION: FABRICATION AND INSTALLATION OF 36 UNITS
SOLAR STREET LIGHTS

TECHNICAL SPECIFICATION

INTRODUCTION

The Technical Specifications describe in detail the work to be executed, the character and quality of materials and workmanship and the specific responsibilities of the Contractor that are not covered by the Conditions of Contract. The Technical Specification shall be read in conjunction with the plans and other contract documents.

Pertinent notes appearing in the Contract Plans or Drawings shall also be considered as part and parcel of the technical specifications. Such notes shall take precedence over the DPWH Standard Specifications and the Supplemental Specifications.

PART E ELECTRICAL WORKS

ITEM 1100 CONDUITS, BOXES & FITTINGS

1100.1 Description

This Item shall consist of the furnishing and installation of the complete conduit work consisting of electrical conduits; conduit boxes such as junction boxes, utility boxes, octagonal and square boxes; conduit fittings such as couplings, locknuts and bushing and other electrical materials needed to complete the conduit roughing-in works.

1100.2 Material Requirements

All materials shall be brand new and shall be of the approved type meeting all the requirements of the Philippine Electrical Code and bearing the Philippine Standard Agency (PSA) mark. The electrical materials to be used shall be of the standard products of the manufacturers regularly engaged in the production of equipment and materials required for this project and shall be the manufacturer's latest standard design that complies with the specification requirements. The Contractor shall submit for approval a complete description of all materials and equipment to be used before commencing the work. The descriptions shall include catalogue numbers, illustrations, diagrams, dimensional data, etc., as required to describe fully the materials.

Conduits

(a) Rigid Steel Conduit shall be electrical metal tubing (EMT) conduit, hot dip galvanized, conforming to ANSI Standard C80.1, or "American Standard Specifications for Steel Conduit, zinc coated" unless shown otherwise in the drawings. The conduit fittings and covers shall be galvanized, threaded, or cadmium plated, grey iron or malleable iron castings. Composite rubber gasket shall be provided in all openings requiring covers. Outlets and pull boxes shall be of the sizes and types shown in the Plan.

(b) Rigid PVC Conduit shall be NEMA TC2, type EPC-PVC and shall be schedule 40. Enamel coated steel conduits and conduits with rough inner surfaces are not acceptable.

Conduit Boxes and Fittings All conduit boxes and fittings shall be Code gauge steel and galvanized. Outlet boxes and fittings shall be galvanized pressed steel of standard make. In general, outlet boxes shall be at least 100mm. square or octagonal, 53 mm. deep and 16 mm. minimum gauge.

1100.3 Construction Requirement

All works throughout shall be executed in the best practice in a workmanlike manner by qualified and experienced electricians under the immediate supervision of a duly licensed Electrical Engineer.

Conduits

Conduits should be cut square with hacksaw and ends reamed. Running or non-tapered threads shall not be used. Each run of conduit between boxes or equipment shall be electrically continuous. Threads shall conform to the American Standard for tapered pipe threads. In making bends only conduit bending apparatus will be used. The use of a pipe tee or vise for bending conduits shall not be permitted. Conduits entering slip holes in boxes shall be secured with a locknut on each side of the box wall and terminated with a bushing.

All joints between lengths of conduits and threaded connections to boxes, fittings and equipment enclosures shall be made watertight. Conduits shall be sloped towards drain points. Conduits shall be rigidly supported and braced to avoid shifting during placement of concrete. Conduits extending out of floors, walls, or beams shall be at right angles to the surfaces.

Spacing of conduits shall be such as to permit the flow of concrete between them. A minimum spacing of not less than 5 cm. shall be maintained, except where conduits enter boxes. Where conduits are placed in two or more layers or rows, the conduits in the upper or inner layers shall be placed directly over or behind the lower or outer layers, respectively.

Conduits terminating at the face of concrete for initial or future extensions as exposed runs shall be terminated with plugged couplings set flush with the floor, ceilings or wall. Galvanized iron plugs shall be provided for conduits, which are to be extended in the future. Where it is not practical to employ flush couplings, the conduit ends shall be suitably boxed or otherwise protected and plugged. Conduits running in floors and terminating at motors or other equipment mounted on concrete bases shall be brought up to the equipment within the concrete base wherever possible. Conduit boxes shall be flush with the finished wall with covers and openings easily accessible. The Contractor shall remove and reset all boxes not properly installed or shifted out of line during concreting to the satisfaction of the Engineer.

Conduit Boxes & Fittings Each outlet in the drawing or raceway system shall be provided with an outlet box to suit the conditions encountered. Boxes for exposed work or in wet locations shall be of the cast metal type having threaded hubs. Boxes for concealed work shall be the cadmium-plated or zinc-coated sheet metal type. Each box shall have sufficient volume to accommodate the number of conductors entering the box.. Boxes shall not be less than 50 mm deep unless shallower boxes are required by structural conditions that are specifically approved by the Engineer.

Ceiling and bracket outlet boxes shall not be less than 100 mm octagonal except that smaller boxes may be used where required by the particular fixtures to be installed. Switch and receptacle boxes shall be approximately 100 mm x 50 mm x 50 mm. Telephone outlets shall be 100 mm square except that 100 mm x 54 mm x 40 mm boxes may be used where only one raceway enter the outlet. Boxes installed in concealed locations shall be set flush with the finished surfaces and shall be provided with the proper extension rings or plaster covers where required.

Boxes shall be installed in a rigid and satisfactory manner and shall be supported by bar hangers in frame construction, or shall be fastened directly with wood screws on wood. Location of outlets shown on the drawings are approximate; the Contractor shall study the building plans in relation to the spaces and equipment surrounding each outlet so that the lighting fixtures are symmetrically located according to the room layout. When necessary, with the approval of the Consultant, outlets shall be relocated to avoid interference with mechanical equipment or structural features.

Conduit Boxes & Fittings Provide conduit boxes for pulling and splicing wires and outlet boxes for installation of wiring devices. As a rule, provide junction boxes or pull boxes in all runs greater than 30 meters in length, for horizontal runs. For other lengths, provide boxes as required for splices or pulling. Pull boxes shall be installed in conspicuous but accessible locations. Support boxes independently of conduits entering by means of bolts, rod hangers or other suitable means. Conduit boxes shall be installed plumb and securely fastened. They shall be set flush with the surface of the structure in which they are installed where conduits are run concealed.

All convenience and wall switch outlet boxes for concealed conduit work shall be deep, rectangular flush type boxes. Four inch octagonal flush type boxes shall be used for all ceiling light outlets and shall be of the deep type where three or more conduits connect to a single box. Floor mounted outlet boxes required shall be waterproof type with flush brass floor plate and brass bell nozzle. All boxes shall be painted with anti-rust red lead paint after installation. All conduits shall be fitted with approved standard galvanized bushing and locknuts where they enter cabinets and conduit boxes. Junction and pull boxes of code gauge steel shall be provided as indicated or as required to facilitate the pulling of wires and cables.

1100.4 Method of Measurement

The work under this Item are inclusive in Item 1101 (Wires and Wiring Devices) and shall be measured either by lengths, pieces, pairs, lot and actually placed and installed as shown on the Plans.

1100.6 General Specifications

The work to be done under this division of specifications consist of the fabrication, furnishing, delivery and installation, complete in all details of the electrical work, at the subject premises and all work materials incidental to the proper completion of the installation, except those portions of the work which are expressly stated to be done by other fields. All works shall be done in accordance with the rules and regulations and with the specifications.

1100.7 Specifications on:

1. Lightning Fixtures and Lamp

All lightning fixtures and lamps of type and sizes as specified and listed on the Lighting Fixture Schedule and shall be furnished and installed complete. Incandescent lamps shall be inside frosted lamp, 230 volts, and wattage as indicated. All Fluorescent lamps shall be 40 watt, pre-heat type, rapid start, cool white color characteristics and shall have complete high frequency electronic ballast, 230 volt. Fixtures are designated by letters and illustrations shall be indicative of the general type desired and shall not restrict selection to fixtures of any particular manufacturer. Fixtures of similar design and equivalent light distribution and brightness characteristics having equal finish and quality maybe acceptable but subject to the approval of the Engineer.

2. Material Requirements

All materials to be used shall conform to the BPS specification

3. Construction Requirements

All grounding system installation shall be executed in accordance with the approved plans. Grounding system shall include building perimeter ground wires, ground rods, clamps, connectors, ground wells and ground wire taps as shown in the approved design.

1100.8 Auxiliary Systems

All auxiliary systems such as telephone and intercom system, time clock system, fire alarm system and public address/paging system installations shall be done in accordance with the approved design. All materials to be used shall conform to the Bureau of Product Standards (BPS) specifications.

1100.9 Important requirement regarding supervision of the work and submission of certificate of completion. All wiring installation herein shall be done under the direct supervision of a licensed Electrical Engineer at the expense of the Contractor. The Contractor shall submit the request for the Clearance to Proceed duly approved by the owner's representative.

1100.10 Test and Guarantee

Upon completion of the electrical construction work, the Contractor shall provide all test equipment and personnel and to submit written copies of all test results. The Contractor shall guarantee the electrical installation are done and in accordance with the approved Plans and specification. The Contractor shall guarantee that the electrical system are free from all grounds from all defective workmanship and materials and will remain so for a period of one year from date and acceptance of works. Any defect shall be remedied by the Contractor at his own expense.

ITEM 1101 WIRES AND WIRING DEVICES

1101.1 Description

This Item shall consist of the furnishing and installation of all wires and wiring devices consisting of electrical wires and cables, wall switches, convenience receptacles, heavy duty

receptacles and other devices shown on the approved Plans but not mentioned in this Specification.

1101.2 Material Requirements

Wires and cables shall be of the approved type meeting all the requirements of the Philippine Electrical Code and bearing the PSA mark unless specified or indicated otherwise, all power and lighting conductor shall be insulated for 600 Volts. All wires shall be copper, soft drawn and annealed, smooth and cylindrical form and shall be centrally located inside the insulation. All wiring devices shall be standard product of reputable electrical manufacturers. Wall switches shall be rated at least 10A, 250 Volts and shall be spring operated, flush, tumbler type. Duplex convenience receptacles shall be rated at least 15A, 250 Volts, flush, parallel slot single heavy duty receptacles shall be rated at least 20 A, 250 Volts, wire, flush, polarize type. Conductors in conduits shall be moisture and heat-resistant rubber or thermoplastic insulated. In dry locations, wires and cables shall be type THW for sizes 8 mm. and smaller and type THW or THHN for sizes 14 sq. mm. and larger. In damp or wet locations as defined by the Philippine Electric Code, wires and cables shall be type THW. All conductors shall have 600 volts insulation unless otherwise specified in the drawings. Wire shall be stranded copper for 5.5 mm. diameter and larger sizes. Wires for the telephone and signalling systems shall be twisted telephone wires, thermoplastic insulated. The number and sizes shall be as specified in the drawings.

1101.3 Construction Requirements

Conductors of wires shall not be drawn in conduit until after the cement plaster is dry and the conduits are thoroughly cleaned and free from dirt and moisture. In drawing wires into conduits, sufficient slack shall be allowed to permit easy connection for fixtures, switches, receptacles and other wiring devices without the use of additional splice:

All conductors of convenience outlets and lighting branch circuit home runs shall be wired with a minimum of 3.5 mm. in size. Circuit home runs to panel boards shall not be smaller than 3.5 mm. but a home run to panel board more than 30 meters shall not be smaller than 5.5 mm. No conductor shall be less than 2 mm. in size. All wires of 14 mm. and larger in size shall be connected to panel and apparatus by means of approved type lugs or connectors of the solderless type, sufficiently large enough to enclose all strands of the conductors and securely fasten. They shall not loosen under vibration of normal strain. All joints, taps and splices on wires larger than 14 mm. shall be made of suitable solderless connectors of the approved type and size. They shall be taped with rubber and PVC tapes providing insulation no less than that of the conductors.

No splices or joints shall be permitted in either feeder or branch conductors except within outlet boxes or accessible junction boxes (pull boxes). All joints in branch circuit wiring shall be made mechanically and electrically secured by approved splicing devices taped with rubber and PVC tapes in a manner which will make their insulation as that of the conductor. All wall switches and receptacle shall be fitted with standard bakelite face plate covers. Device plate for flush mounting shall be installed with all four edges in continuous contact finished wall surfaces without the use of coiled wire or similar devices. Plaster fillings will not be permitted. Plate installed in wet locations shall be gasketed. When more than one switch or device is indicated in a single location gang plate shall be used.

1101.3.1 Quality Assurance Provisions

All installation shall be completed on or before final acceptance of the project including the tests and commissioning. Equipment shall be demonstrated to operate in accordance with the requirements of this specification. The Contractor shall furnish all instruments, tools and personnel required for the tests. As an exception to requirements that may be stated elsewhere in the contract agreement, the Engineer shall be given five (5) working days notice prior to each test. All defects disclosed as a result of such test that are due to the Contractor and shall be remedied to the satisfaction of the Engineer.

(a) Devices subject to Manual Operation

Each device subject to manual operation shall be tested five (5) times demonstrating satisfactory operation each time.

(b) Test on 600 Volts Wiring

Test of all 600 volts wiring to verify that no circuits or accidental grounds exist. Perform insulation resistance test on all wiring using an instrument which apply a voltage of approximately 500 volts to provide a direct reading of resistance; minimum resistance shall be 250,000 ohms that the resistance to ground is not excessive. Test each ground rod for resistance to ground before making any connections to the rod, then tie entire grounding system together and test for resistance to ground. Make resistance measurements in normally dry weather condition, not less than 48 hours after rainfall. Submit written results of each test to the Engineer and indicate the locations of the rod as well as the resistance and soil conditions at the time of the measurements were made.

1101.4 Method of Measurement

The work under this Item shall be measured either by meters, rolls, pieces, set, actually placed and installed as shown on the Plans.

1101.5 Basis of Payment

All work performed and measured and as provided for in his Bill of Quantities shall be paid for at the Unit Bid or contract unit price which payment shall constitute full compensation including labor, materials, tools and incidentals necessary to complete this Item.

Payment shall be made under:

Pay Item Number	Description	Unit of Measurement
1101 (1)	Electric wire (size), conduits with Fittings	meter
1101 (2)	Single pole tumbler switch set	
1101 (3)	Two-gang Tumbler switch set	
1101 (4)	Three-gang Tumbler switch set	
1101 (5)	Three-way tumbler switch set	
1101 (6)	Duplex convenience outlet set	
1101 (7)	Heavy duty convenience receptacle set	
1101 (8)	Standard Telephone outlet Bakelite cover set	

- 1101 (9) Window type air conditioning Outlet 3-prong polarized type set
- 1101 (10) Bare copper wire meters
- 1101 (11) Grounding clamp for electric wire pieces
- 1101 (12) Messenger wire meters
- 1101 (13) Guy wire meters
- 1101 (14) Vibrating bell set
- 1101 (15) Traffic Light Control Panel set
- 1101 (16) Traffic Light metal enclosures Complete with red & green light provided with reflectors & 152 mm diameter vibrating bell set
- 1101 (17) Service entrance assembly with Reinforced concrete Pedestal pole with anchor bolt set
- 1101 (18) Meter base assembly exposed rigid RCP with weather cap & grounding rod copper weld 20 mm. diameter x 3 m.set
- 1101 (19) Apitong or approved equal Creosoted wood pole of std. length with anchor rod & log set

ITEM 1102 POWER LOAD CENTER, SWITCHGEAR AND PANELBOARDS

1102.1 Description

This Item shall consist of the furnishing and installation of the power load center unit substation or low voltage switchgear and distribution panel boards at the location shown or the approved Plans complete with transformer, circuit breakers, cabinets and all accessories, completely wired and ready for service.

1102.2 Material Requirements

All materials shall be brand new and shall be of the approved type. It shall conform with the requirements of the Philippine Electrical Code and shall bear the Philippine Standard Agency (PSA) mark.

Power Load Center Unit Substation

The Contractor shall furnish and install as indoor-type Power Load center Unit Substation at the location shown on the approved Plans if required. It shall be totally metal-enclosed, dead front and shall consist of the following coordinated component parts:

High Voltage primary Section

High voltage primary incoming line section consisting of the following parts and related accessories:

- e) One (1) Air-filled interrupter Switch, 2-position (open-close) installed in a suitable air filled metal enclosure and shall have sufficient interrupting capacity to carry the electrical load. It shall be provided with key interlock with the cubicle for the power fuses to prevent access to the fuses unless the switch is open.
- f) Three (3) power fuses mounted in separate compartments within the switch housing and

accessible by a hinged door.

g) One (1) set of high voltage potheads or 3-conductor cables or three single conductor cables.

h) Lighting arresters shall be installed at the high voltage cubicle if required.

Items (a) and (b) above could be substituted with a power circuit breaker with the correct rating and capacity.

Transformer Section

The transformer section shall consist of a power transformer with ratings and capacities as shown on the Plans. It shall be oil liquid-filled non-flammable type and designed in accordance with the latest applicable standards.

The transformers shall be provided with four (4) approximately 2 ½ % rated KVA taps on the primary windings in most cases one (1) above and three (3) below rated primary voltage and shall be changed by means of externally gang-operated manual tap changer only when the transformer is de-energized. Tap changing under load is acceptable if transformer has been so designed.

The following accessories shall be provided with the transformer, namely: drain pad, top filter press connection, lifting lugs, diagrammatic nameplate, relief valve, thermometer and other necessary related accessories.

The high voltage and low voltage bushings and transition flange shall be properly coordinated for field connection to the incoming line section and low voltage switchboard section, respectively.

Low-Voltage Switchboard Section

The low-voltage switchboard shall be standard modular-unitized units, metal-built, dead front, safety type construction and shall consist of the following:

e) Switchboard Housing

The housing shall be heavy gauge steel sheet, dead front type, gray enamel finish, complete with frame supports, steel bracings, steel sheet panelboard, removable rear plates, copper busbars, and all other necessary accessories to ensure sufficient mechanical strength and safety. It shall be provided with grounding bolts and clamps.

f) Secondary Metering Section

The secondary metering section shall consist of one (1) ammeter, AC, Indicating type; one voltmeter, AC, Indicating Type, one (1) ammeter transfer switch for 3-phase; one (1) voltmeter transfer switch for 3-phase; and current transformers of suitable rating and capacity.

The above mentioned instruments shall be installed in one compartment above the main breaker and shall be complete with all necessary accessories completely wired, ready for use.

g) Main Circuit Breaker

The main circuit breaker shall be draw-out type, manually or electrically operated, manual trip

bottom, magnetic tripping devices, adjustable time overcurrent protection and instantaneous shortcircuit trip and all necessary accessories to ensure safe and efficient operation.

h) Feeder Circuit Breakers

There shall be as many feeder breakers as are shown on the single line diagram or schematic riser diagram and schedule of loads and computations on the Plans. The circuit breaker shall be drawnout or molded case as required. The circuit breakers shall each have sufficient interrupting capacity and shall be manually operated complete with trip devices and all necessary accessories to insure safe and efficient operation. The number, ratings, capacities of the feeder branch circuit breakers shall be shown on the approved Plans.

Circuit breakers shall each be of the indicating type, providing "ON" – "OFF" and "TRIP" positions of the operating handles and shall each be provided with nameplate for branch circuit designation. The circuit breaker shall be so designed that an overload or short on one pole automatically causes all poles to open.

Low-Voltage Switchgear (For projects requiring low-voltage Switchgear only)

The Contractor shall furnish and install a low-voltage switchgear at the location shown on the Plans. It shall be metal-clad, dead front, free standing, safety type construction and shall have copper busbars of sufficient size, braced to resist allowable Root Mean Square (RMS) symmetrical shortcircuit stresses, and all necessary accessories. The low-voltage switchgear shall consist of the switchgear housing, secondary metering, main breaker and feeder branch circuit breakers and all necessary accessories, completely wired, ready for service.

Grounding System

All non-current carrying metallic parts like conduits, cabinets and equipment frames shall be properly grounded in accordance with the Philippine Electrical Code, latest edition.

The size of the ground rods and ground wires shall be as shown on the approved Plans. The ground resistance shall not be more than 5 ohms.

Panel boards and cabinets

Panel boards shall conform to the schedule of panel boards as shown on the approved Plans with respect to supply characteristics, rating of main lugs or main circuit breaker, number and ratings and capabilities of branch circuit breakers.

Panel boards shall consist of a factory completed dead front assembly mounted in an enclosing flush type cabinet consisting of code gauge 14 (2.0 mm thick) galvanized sheet steel box with trim and door. Each door shall be provided with catch lock and two (2) keys. Panel boards shall be provided with directories and shall be printed to indicate load served by each circuit.

Panel board cabinets and trims shall be suitable for the type of mounting shown on the approved Plans. The inside and outside of panel board cabinets and trims shall be factory painted with one rust-proofing primer coat and two finish shop coats of pearl gray enamel paint.

Main and branch circuit breakers for panel boards shall have the rating, capacity and number of poles as shown on the approved Plans. Breakers shall be thermal magnetic type. Multiple breakers shall be of the common trip type having a single operating handle. For 50-ampere breaker or less, it may consist of single-pole breaker permanently assembled at the factory into a multi-pole unit.

1102.3 Construction Requirements

The Contractor shall install the Power Load center Unit Substation or Low-Voltage Switchgear and panel boards at the locations shown on the approved Plans.

Standard panels and cabinets shall be used and assembled on the job. All panels shall be of dead front construction furnished with trims for flush or surface mounting as required.

1102.4 Method of Measurement

The work under this Item shall be measured either by set and pieces actually placed and installed as shown on the approved Plans.

1102.5 Basis of Payment

All works performed and measured and as provided for in the Bill of Quantities shall be paid for the Unit Bid or Contract Unit Price which payment shall constitute full compensation including labor, materials, tools and incidentals necessary to complete this Item.

Payment shall be made under:

Pay Item Number	Description	Unit of Measurement
1102 (1)	Panelboard (circuit breaker type)	set
1102 (2)	Panelboard (Safety Switch type)	set
1102 (3)	Low-Voltage Switchgear (LVS) Complete with metering devices And accessories	set
1102 (4)	Power Fuses	pieces
1102 (5)	Lighting Arrester	pieces
1102 (6)	Air Break Switch	set
1102 (7)	Enclosed ACB NEMA Type I	set
1102 (8)	Enclosed ACB NEMA Type 3R	set
1102 (9)	Automatic Transfer Switch	set
1102 (10)	Manual Transfer Switch w/out fuses	pieces
1102 (11)	Motor Controller	set

Section VII. Drawings

[Insert here a list of Drawings. The actual Drawings, including site plans, should be attached to this section, or annexed in a separate folder.]

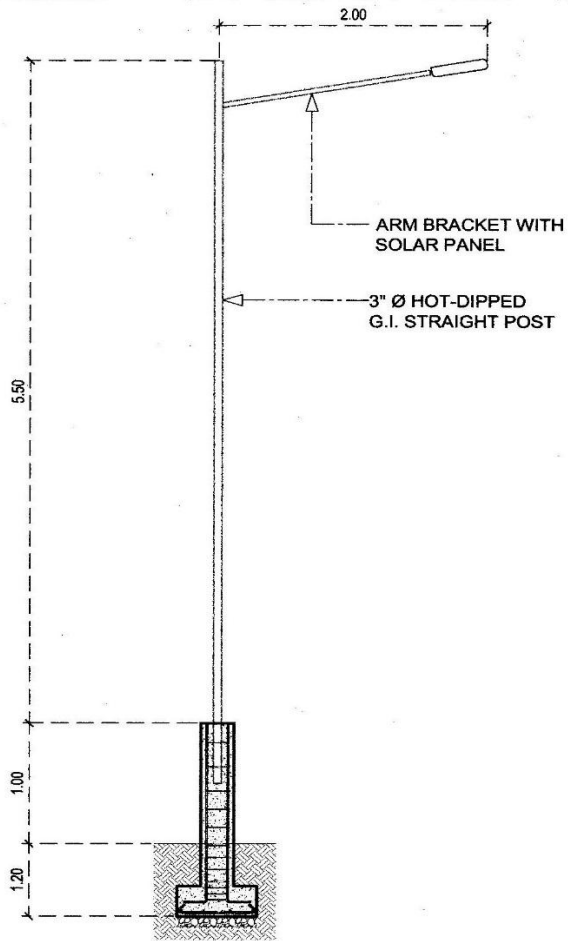



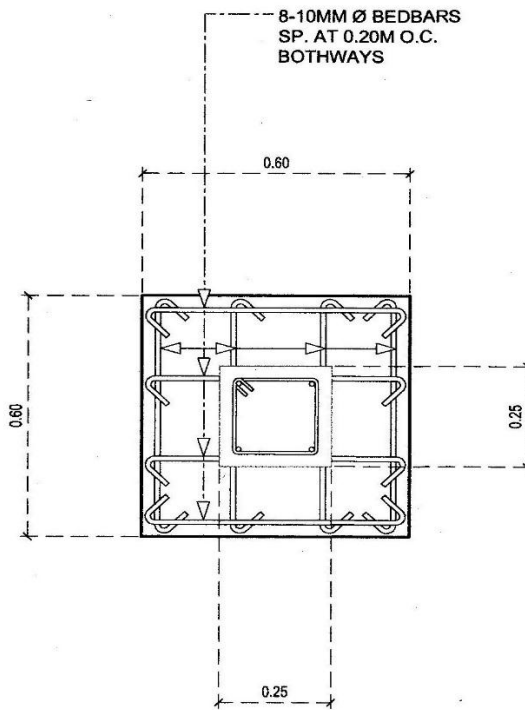

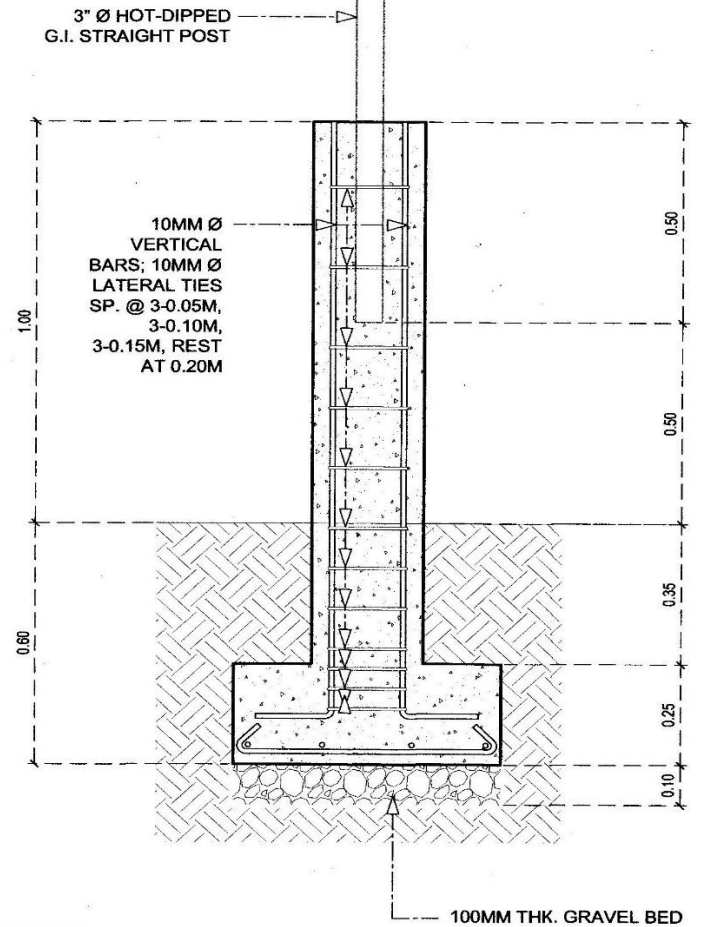

SOLAR STREET LIGHT DETAIL
 SCALE 1:50 MTS.



COLUMN FOOTING DETAIL
 SCALE 1:15 MTS.



	REPUBLIC OF THE PHILIPPINES MUNICIPALITY OF COMPOSTELA PROVINCE OF DAVAO DE ORO OFFICE OF THE MUNICIPAL ENGINEER / BUILDING OFFICIAL	PROJECT TITLE: INSTALLATION OF SOLAR STREET LIGHTS	SHEET CONTENT: SOLAR STREET LIGHT DETAIL COLUMN FOOTING DETAIL	PREPARED BY:  RIANG ACASO, UAP <small>REGISTERED</small>	CHECKED AND REVIEWED BY:  RUSSTAN B. CALOLO, CE <small>REGISTERED</small>	APPROVED BY:  LEONILO D. CAVAN, CE <small>REGISTERED</small>	NOTED BY:  FELICITIA R. DETROS, CE <small>MUNICIPAL ENGINEER</small>	NOTED BY:  LEVI S. BESADA <small>MUNICIPAL MAYOR</small>	SHEET NO.
	LOCATION: COMPOSTELA, DAVAO DE ORO BRGY. LAGAB								

Section VIII. Bill of Quantities

Project Title: *Re-bid: Installation of Solar Street Lights - Lagab*
ABC (Php): 999,999.84

Project Title: <i>Re-bid: Installation of Solar Street Lights - Lagab</i>					
ABC (Php): <i>999,999.84</i>					
Item No.	Description of Works	Quantity	Unit	Unit Price (In words & figures)	Total Price (In words & figures)
1.	I - GENERAL REQUIREMENTS	1	lot		
2.	II. Electrical Works Specification LED Solar Streetlight: 400w Integrated, IP66 Solar Panel: 6V/56w Polycrystalline Silicon Battery: LiFePo4 Lithium Iron Battery Life: 8years Led Chip: Cree Light Output: 4000lm Life time: 50,000hrs CCT: 3000-6500k Shell Material: Aluminium Alloy Working Model: Time Control Charging Time: 6-8hrs Discharge Time: 2-3 rainy days, 10-12 hours IP Rating: IP66 Mounting Height: 6m Certificate: CE, ROHS, IP66 Warranty: 2 years warranty	36	units		
3.	III - CIVIL WORKS	36	units		
<i>GRAND TOTAL (In words and Figures)</i>					

Note: Total cost of line item includes cost of Contractor's Profit, VAT Tax, others

Name of Bidder	Authorized Signatory	Date
----------------	----------------------	------

Section IX. Checklist of Technical and Financial Documents

Checklist of Technical and Financial Documents

I. TECHNICAL COMPONENT ENVELOPE

Class “A” Documents

Legal Documents

- (a) Valid PhilGEPS Registration Certificate (Platinum Membership) (all pages);
or
- (b) Registration certificate from Securities and Exchange Commission (SEC), Department of Trade and Industry (DTI) for sole proprietorship, or Cooperative Development Authority (CDA) for cooperatives or its equivalent document;
and
- (c) Mayor’s or Business permit issued by the city or municipality where the principal place of business of the prospective bidder is located, or the equivalent document for Exclusive Economic Zones or Areas;
and
- (e) Tax clearance per E.O. No. 398, s. 2005, as finally reviewed and approved by the Bureau of Internal Revenue (BIR).

Technical Documents

- (f) Statement of the prospective bidder of all its ongoing government and private contracts, including contracts awarded but not yet started, if any, whether similar or not similar in nature and complexity to the contract to be bid; **and**
- (g) Statement of the bidder’s Single Largest Completed Contract (SLCC) similar to the contract to be bid, except under conditions provided under the rules; **and**
- (h) Philippine Contractors Accreditation Board (PCAB) License;
or
Special PCAB License in case of Joint Ventures;
and registration for the type and cost of the contract to be bid; **and**
- (i) Original copy of Bid Security. If in the form of a Surety Bond, submit also a certification issued by the Insurance Commission;
or
Original copy of Notarized Bid Securing Declaration; **and**
- (j) Project Requirements, which shall include the following:
 - a. Organizational chart for the contract to be bid;
 - b. List of contractor’s key personnel (*e.g.*, Project Manager, Project Engineers, Materials Engineers, and Foremen), to be assigned to the contract to be bid, with their complete qualification and experience data;
 - c. List of contractor’s major equipment units, which are owned, leased, and/or under purchase agreements, supported by proof of ownership or certification of availability of equipment from the equipment lessor/vendor for the duration of the project, as the case may be;
 - d. Affidavit of Site Inspection;
 - e. Construction schedule and S-curve;
 - f. Manpower schedule;
 - g. Construction methods;
 - h. Equipment utilization schedule;

- i. Construction Safety and Health Program approved by DOLE – to be submitted on the first billing;
- j. PERT/CPM **and**
- (k) Original duly signed Omnibus Sworn Statement (OSS); **and** if applicable, Original Notarized Secretary’s Certificate in case of a corporation, partnership, or cooperative; or Original Special Power of Attorney of all members of the joint venture giving full power and authority to its officer to sign the OSS and do acts to represent the Bidder.
- (l) Mayor’s Permit (Municipality of Compostela)
- (m) Bidder’s Fee (Official Receipt)

Financial Documents

- (n) The prospective bidder’s audited financial statements, showing, among others, the prospective bidder’s total and current assets and liabilities, stamped “received” by the BIR or its duly accredited and authorized institutions, for the preceding calendar year which should not be earlier than two (2) years from the date of bid submission; **and**
- (o) The prospective bidder’s computation of Net Financial Contracting Capacity (NFCC).

Class “B” Documents

- (p) If applicable, duly signed joint venture agreement (JVA) in accordance with RA No. 4566 and its IRR in case the joint venture is already in existence;
or
duly notarized statements from all the potential joint venture partners stating that they will enter into and abide by the provisions of the JVA in the instance that the bid is successful.

II. FINANCIAL COMPONENT ENVELOPE

- (q) Original of duly signed and accomplished Financial Bid Form; **and**

Other documentary requirements under RA No. 9184

- (r) Original of duly signed Bid Prices in the Bill of Quantities; **and**
- (s) Duly accomplished Detailed Estimates Form, including a summary sheet indicating the unit prices of construction materials, labor rates, and equipment rentals used in coming up with the Bid; **and**
- (t) Cash Flow by Quarter.

Bidding Forms

Bid Form for the Procurement of Infrastructure Projects

BID FORM

Date : _____

Project Identification No. : _____

To: *[name and address of Procuring Entity]*

Having examined the Philippine Bidding Documents (PBDs) including the Supplemental or Bid Bulletin Numbers *[insert numbers]*, the receipt of which is hereby duly acknowledged, we, the undersigned, declare that:

- a. We have no reservation to the PBDs, including the Supplemental or Bid Bulletins, for the Procurement Project: *[insert name of contract]*;
- b. We offer to execute the Works for this Contract in accordance with the PBDs;
- c. The total price of our Bid in words and figures, excluding any discounts offered below is: *[insert information]*;
- d. The discounts offered and the methodology for their application are: *[insert information]*;
- e. The total bid price includes the cost of all taxes, such as, but not limited to: *[specify the applicable taxes, e.g. (i) value added tax (VAT), (ii) income tax, (iii) local taxes, and (iv) other fiscal levies and duties]*, which are itemized herein and reflected in the detailed estimates,
- f. Our Bid shall be valid within the a period stated in the PBDs, and it shall remain binding upon us at any time before the expiration of that period;
- g. If our Bid is accepted, we commit to obtain a Performance Security in the amount of *[insert percentage amount]* percent of the Contract Price for the due performance of the Contract, or a Performance Securing Declaration in lieu of the the allowable forms of Performance Security, subject to the terms and conditions of issued GPPB guidelines for this purpose;
- h. We are not participating, as Bidders, in more than one Bid in this bidding process, other than alternative offers in accordance with the Bidding Documents;
- i. We understand that this Bid, together with your written acceptance thereof included in your notification of award, shall constitute a binding contract between us, until a formal Contract is prepared and executed; and
- j. We understand that you are not bound to accept the Lowest Calculated Bid or any other Bid that you may receive.

- k. We likewise certify/confirm that the undersigned, is the duly authorized representative of the bidder, and granted full power and authority to do, execute and perform any and all acts necessary to participate, submit the bid, and to sign and execute the ensuing contract for the [Name of Project] of the [Name of the Procuring Entity].
- l. We acknowledge that failure to sign each and every page of this Bid Form, including the Bill of Quantities, shall be a ground for the rejection of our bid.

Name: _____

Legal Capacity: _____

Signature: _____

Duly authorized to sign the Bid for and behalf of: _____

Date: _____

STATEMENT OF THE BIDDER OF ALL ITS ONGOING GOVERNMENT AND PRIVATE CONTRACTS, INCLUDING CONTRACTS AWARDED BUT NOT YET STARTED

Business Name: _____

Business Address: _____

Name of Contract	Date of Contract	Contract Duration	Owner's Name & Address	Nature of Work	Contractor's Role		Total Contract Value at Award	Estimated Completion Time	Estimated Contract Value at Completion	% of Accomplish-ments		Value of Outstanding Works
					Description	% of Participation				Planned	Actual	
<u>GOVERNMENT</u>												
<u>PRIVATE</u>												
										TOTAL		

Note: This statement shall be supported with:

1. Notice of Award
2. Contract Agreement

Submitted by: _____

Printed Name and Signature

Designation: _____

Date: _____

STATEMENT OF SINGLE LARGEST COMPLETED CONTRACTS (SLCC)

Business Name: _____

Business Address: _____

Name of Contract	Date of Contract	Owner's Name & Address	Nature of Work	Contractor's Role		Total Contract Value at Award	Date of Completion Time	Total Contract Value at Completion
				Description	% of Participation			
<u>Government</u>								
<u>Private</u>								

Note: This statement shall be supported with:

1. Notice of Award and/or Notice to Proceed
2. Contract Agreement
3. Certificate of Final Acceptance or Constructors Performance Evaluation System (CPES) of at least satisfactory rating.

Submitted by: _____

Printed Name and Signature

Designation: _____

Date: _____

NFCC COMPUTATION

- A. Summary of the Applicant Supplier's/Distributor's/Manufacturer's assets and liabilities on the basis of the attached income tax return and audited financial statement, stamped "RECEIVED" by the Bureau of Internal Revenue or BIR authorized collecting agent, for the immediately preceding year and a certified copy of Schedule of Fixed Assets particularly the list of construction equipment.

		Year 20__
1.	Total Assets	
2.	Current Assets	
3.	Total Liabilities	
4.	Current Liabilities	
5.	Net Worth (1-3)	
6.	Net Working Capital (2- 4)	

- B. The Net Financial Contracting Capacity (NFCC) based on the above data is computed as follows:

NFCC = [(Current Asset – Current Liabilities) (15)] minus value of all outstanding works under ongoing contracts including awarded contracts yet to be started

NFCC = P _____

Submitted by:

Name of Supplier / Distributor / Manufacturer

Signature of Authorized Representative

Date : _____

Bid Securing Declaration Form

[shall be submitted with the Bid if bidder opts to provide this form of bid security]

REPUBLIC OF THE PHILIPPINES)
CITY OF _____) S.S.

BID SECURING DECLARATION **Project Identification No.: *[Insert number]***

To: *[Insert name and address of the Procuring Entity]*

I/We, the undersigned, declare that:

1. I/We understand that, according to your conditions, bids must be supported by a Bid Security, which may be in the form of a Bid Securing Declaration.
2. I/We accept that: (a) I/we will be automatically disqualified from bidding for any procurement contract with any procuring entity for a period of two (2) years upon receipt of your Blacklisting Order; and, (b) I/we will pay the applicable fine provided under Section 6 of the Guidelines on the Use of Bid Securing Declaration, within fifteen (15) days from receipt of the written demand by the procuring entity for the commission of acts resulting to the enforcement of the bid securing declaration under Sections 23.1(b), 34.2, 40.1 and 69.1, except 69.1(f), of the IRR of RA No. 9184; without prejudice to other legal action the government may undertake.
3. I/We understand that this Bid Securing Declaration shall cease to be valid on the following circumstances:
 - a. Upon expiration of the bid validity period, or any extension thereof pursuant to your request;
 - b. I am/we are declared ineligible or post-disqualified upon receipt of your notice to such effect, and (i) I/we failed to timely file a request for reconsideration or (ii) I/we filed a waiver to avail of said right; and
 - c. I am/we are declared the bidder with the Lowest Calculated Responsive Bid, and I/we have furnished the performance security and signed the Contract.

IN WITNESS WHEREOF, I/We have hereunto set my/our hand/s this ____ day of *[month]* *[year]* at *[place of execution]*.

[Insert NAME OF BIDDER OR ITS AUTHORIZED REPRESENTATIVE]

[Insert signatory's legal capacity]
Affiant

[Jurat]

[Format shall be based on the latest Rules on Notarial Practice]

Omnibus Sworn Statement (Revised)

[shall be submitted with the Bid]

REPUBLIC OF THE PHILIPPINES)
CITY/MUNICIPALITY OF _____) S.S.

AFFIDAVIT

I, [Name of Affiant], of legal age, [Civil Status], [Nationality], and residing at [Address of Affiant], after having been duly sworn in accordance with law, do hereby depose and state that:

1. *[Select one, delete the other:]*

[If a sole proprietorship:] I am the sole proprietor or authorized representative of [Name of Bidder] with office address at [address of Bidder];

[If a partnership, corporation, cooperative, or joint venture:] I am the duly authorized and designated representative of [Name of Bidder] with office address at [address of Bidder];

2. *[Select one, delete the other:]*

[If a sole proprietorship:] As the owner and sole proprietor, or authorized representative of [Name of Bidder], I have full power and authority to do, execute and perform any and all acts necessary to participate, submit the bid, and to sign and execute the ensuing contract for [Name of the Project] of the [Name of the Procuring Entity], as shown in the attached duly notarized Special Power of Attorney;

[If a partnership, corporation, cooperative, or joint venture:] I am granted full power and authority to do, execute and perform any and all acts necessary to participate, submit the bid, and to sign and execute the ensuing contract for [Name of the Project] of the [Name of the Procuring Entity], as shown in the attached [state title of attached document showing proof of authorization (e.g., duly notarized Secretary's Certificate, Board/Partnership Resolution, or Special Power of Attorney, whichever is applicable)];

3. [Name of Bidder] is not "blacklisted" or barred from bidding by the Government of the Philippines or any of its agencies, offices, corporations, or Local Government Units, foreign government/foreign or international financing institution whose blacklisting rules have been recognized by the Government Procurement Policy Board, **by itself or by relation, membership, association, affiliation, or controlling interest with another blacklisted person or entity as defined and provided for in the Uniform Guidelines on Blacklisting;**

4. Each of the documents submitted in satisfaction of the bidding requirements is an authentic copy of the original, complete, and all statements and information provided therein are true and correct;

5. [Name of Bidder] is authorizing the Head of the Procuring Entity or its duly authorized representative(s) to verify all the documents submitted;

6. *[Select one, delete the rest:]*
[If a sole proprietorship:] The owner or sole proprietor is not related to the Head of the Procuring Entity, members of the Bids and Awards Committee (BAC), the Technical Working Group, and the BAC Secretariat, the head of the Project Management Office or the end-user unit, and the project consultants by consanguinity or affinity up to the third civil degree;
- [If a partnership or cooperative:]* None of the officers and members of *[Name of Bidder]* is related to the Head of the Procuring Entity, members of the Bids and Awards Committee (BAC), the Technical Working Group, and the BAC Secretariat, the head of the Project Management Office or the end-user unit, and the project consultants by consanguinity or affinity up to the third civil degree;
- [If a corporation or joint venture:]* None of the officers, directors, and controlling stockholders of *[Name of Bidder]* is related to the Head of the Procuring Entity, members of the Bids and Awards Committee (BAC), the Technical Working Group, and the BAC Secretariat, the head of the Project Management Office or the end-user unit, and the project consultants by consanguinity or affinity up to the third civil degree;
7. *[Name of Bidder]* complies with existing labor laws and standards; and
8. *[Name of Bidder]* is aware of and has undertaken the responsibilities as a Bidder in compliance with the Philippine Bidding Documents, which includes:
- a. Carefully examining all of the Bidding Documents;
 - b. Acknowledging all conditions, local or otherwise, affecting the implementation of the Contract;
 - c. Making an estimate of the facilities available and needed for the contract to be bid, if any; and
 - d. Inquiring or securing Supplemental/Bid Bulletin(s) issued for the *[Name of the Project]*.
9. *[Name of Bidder]* did not give or pay directly or indirectly, any commission, amount, fee, or any form of consideration, pecuniary or otherwise, to any person or official, personnel or representative of the government in relation to any procurement project or activity.
- 10. In case advance payment was made or given, failure to perform or deliver any of the obligations and undertakings in the contract shall be sufficient grounds to constitute criminal liability for Swindling (Estafa) or the commission of fraud with unfaithfulness or abuse of confidence through misappropriating or converting any payment received by a person or entity under an obligation involving the duty to deliver certain goods or services, to the prejudice of the public and the government of the Philippines pursuant to Article 315 of Act No. 3815 s. 1930, as amended, or the Revised Penal Code.**

IN WITNESS WHEREOF, I have hereunto set my hand this __ day of __, 20__ at _____, Philippines.

[Insert NAME OF BIDDER OR ITS AUTHORIZED REPRESENTATIVE]

[Insert signatory's legal capacity]

Affiant

[Jurat]

[Format shall be based on the latest Rules on Notarial Practice]

FOR YOUR INFORMATION!
BIDDERS/SUPPLIERS/CONTRACTOR'S

ARTICLE 17 – PERMIT FEE FOR PRIVATE CONTRACTORS

Section 85 – DEFINITION OF TERMS

- (A) **“CONTRACTOR”** – includes persons, natural or juridical, not subject to professional tax under Section 139 of the Local Government Code, whose activity consist essentially of the sale of all kinds of goods or services for a fee, regardless of whether or not the performance of the service calls for the exercise or use of the physical or mental faculties of such contractor or his/her employees or supplier, manufacturer of heavy or light equipment and the likes.

SECTION 86 – TAX ON BUSINESS SITUATED OUTSIDE THE MUNICIPALITY

A tax shall be imposed to any person or entity whose business is situated outside the Municipality after participating a public bidding or other modality of procurement have been awarded the contract subject to the existing tax schedule promulgated for the purpose and the nature of business as defined herein.

The total contract cost shown in the Purchase Order and or Contract Agreement shall be the amount subject to tax. Corresponding deduction shall be made for each transaction and for any and all voucher made as payment of obligation incurred after full delivery of goods and services and acceptance thereof.

SECTION 87 – IMPOSITION OF CONTRACTOR PERMIT FEE

That any individual, person, company, corporation or having juridical entity shall secure necessary permit and **shall pay a Contractor Permit Fee of One Percent (1%) based on the Project Cost.**

SECTION 88 – TIME OF PAYMENT

The fee is imposed shall be payable before issuance of Notice to Proceed or Notice of Award or shall be made before the commencement of the work.

As per 2022 Revised Omnibus Revenue Code of the Municipality of Compostela

